

**Stack Parking – Stackers With Pit**

Stackers with pit add independent access to each car. Both upper and lower level cars are parked on platforms that move up and down together allowing each car to be driven on or off independently of each other.

► **swiss-park S-2 Exclusive**

The **S-2 Exclusive** creates a two level garage on one floor with maximum clearance for tall vehicles. The **Exclusive** is best suited for mid-size self-park garages where simplicity and comfort are a priority.

**Dimensions**

All space requirements are minimum finished dimensions. Tolerances for space requirements + 3. Dimensions in cm.

EB (single platform) = 2 vehicles  
DB (double platform) = 4 vehicles

| Type     | H   | DH** |
|----------|-----|------|
| S-2 170  | 325 | 156  |
| S-2 185* | 340 | 171  |
| S-2 195  | 350 | 181  |

\* standard type  
\*\* without car

**Suitable for**

Standard passenger car and station wagon. Height and length according to contour.

| Type     | H   | car height  |              |
|----------|-----|-------------|--------------|
|          |     | upper floor | ground floor |
| S-2 170  | 325 | 150         | 150          |
| S-2 185* | 340 | 150         | 165          |
| S-2 195  | 350 | 150         | 175          |

\* standard type

|            |              |
|------------|--------------|
| width      | 1.90 m       |
| weight     | max. 2000 kg |
| wheel load | max. 500 kg  |

**Garage with door in front of the stack parking system**

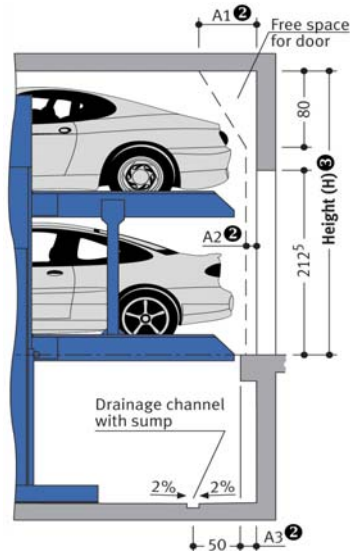

S-2 185

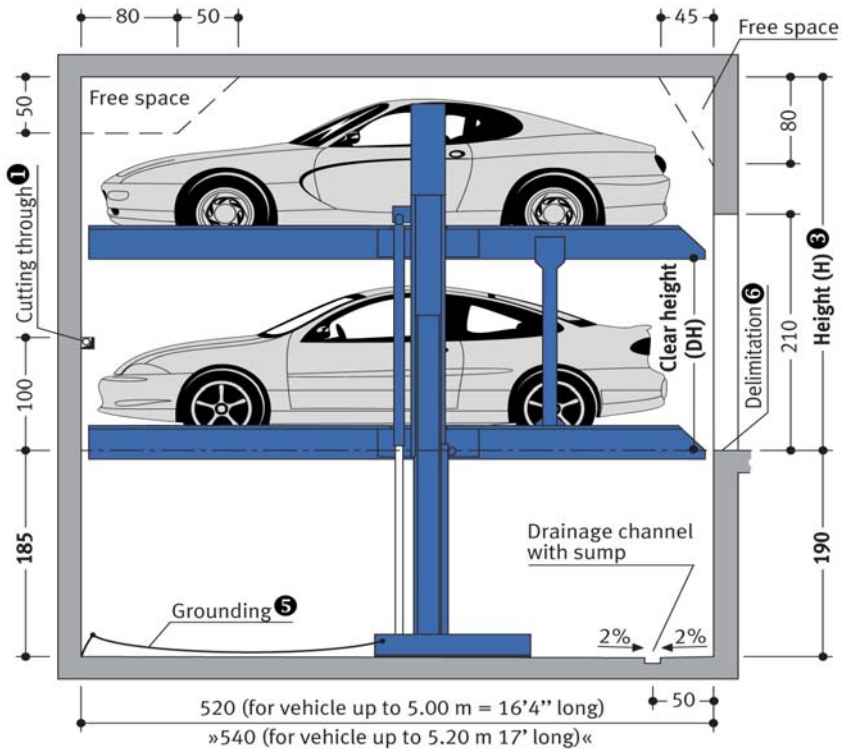

S-2 170

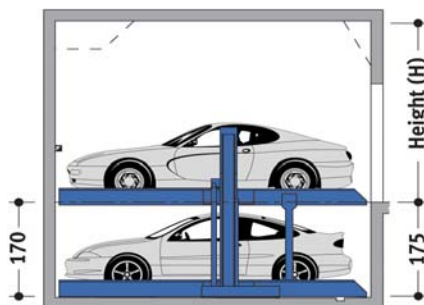

S-2 195 4

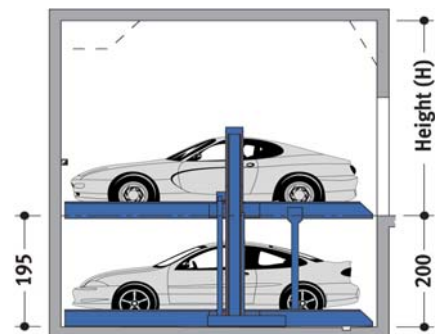

**Notes**

- 1 For dividing walls: cutting through 10 x 10 cm (for pipes).
- 2 Dimensions A1, A2 and A3 must be coordinated with the door supplier.
- 3 If the total height is greater, the max. vehicle height for the upper parking space increases accordingly.
- 4 For the greatest possible ease-of-use, we recommend platform widths of 250 to 270 (EB) or 500 (DB).
- 5 Potential equalization from foundation grounding connection to system.
- 6 In compliance with DIN EN 14 010, 10 cm wide yellow-black markings compliant to ISO 3864 must be applied by the customer to the edge of the pit in the entry area to mark the danger zone (see »load plan« page 3).

**Attention**

For cars up to a length of 5.20 m please note: Pit length 5.40 m (with towbar 5.50 m), max. authorized loading 2500 kg (wheel load max. 625 kg), usable platform width 2.50 –2.70 m. Only Stack Parker S-2-170/185/195 EB is possible. Special model!

**Horizontal Design Dimensions**

**Dividing walls**

Single Platform (EB)



| usable platform width | B1  |
|-----------------------|-----|
| 230 *                 | 260 |
| 240                   | 270 |
| 250                   | 280 |
| 260                   | 290 |
| 270                   | 300 |

Double Platform (DB)

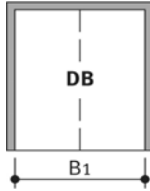

| usable platform width | B1  |
|-----------------------|-----|
| 460 *                 | 490 |
| 470                   | 500 |
| 480                   | 510 |
| 490                   | 520 |
| 500                   | 530 |

Single and Double Platform (EB + DB) – Example

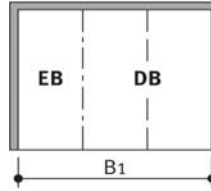

| usable platform width | B1  |
|-----------------------|-----|
| 230 + 460 *           | 750 |
| 240 + 470             | 770 |
| 250 + 480             | 790 |
| 250 + 500             | 810 |
| 270 + 500             | 830 |

Carriageway in accordance with local regulations

\* standard type

**Columns inside of pit**

Single Platform (EB)

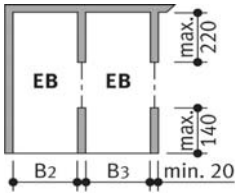

| usable platform width | B2  | B3  |
|-----------------------|-----|-----|
| 230 *                 | 255 | 250 |
| 240                   | 265 | 260 |
| 250                   | 275 | 270 |
| 260                   | 285 | 280 |
| 270                   | 295 | 290 |

Double Platform (DB)

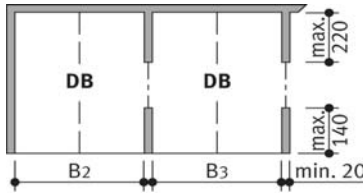

| usable platform width | B2  | B3  |
|-----------------------|-----|-----|
| 460 *                 | 485 | 475 |
| 470                   | 495 | 485 |
| 480                   | 505 | 495 |
| 490                   | 515 | 505 |
| 500                   | 525 | 515 |

Single and Double Platform (EB + DB) – Example

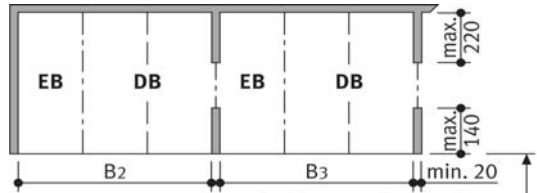

| usable platform width | B2  | B3  |
|-----------------------|-----|-----|
| 230 + 460 *           | 745 | 735 |
| 240 + 470             | 765 | 755 |
| 250 + 480             | 785 | 775 |
| 250 + 500             | 805 | 795 |
| 270 + 500             | 825 | 815 |

Carriageway in accordance with local regulations

\* standard type

**Approach**

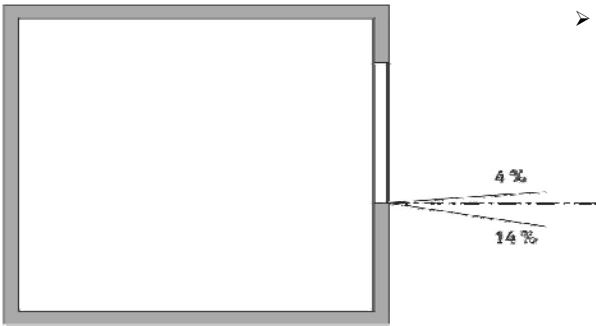

- The illustrated maximum approach angles must not be exceeded. Incorrect approach angles will cause serious manoeuvring & positioning problems on the parking system for which the local agency of **SWISS-PARK** accepts no responsibility.

**Load plan**

Forces in kN

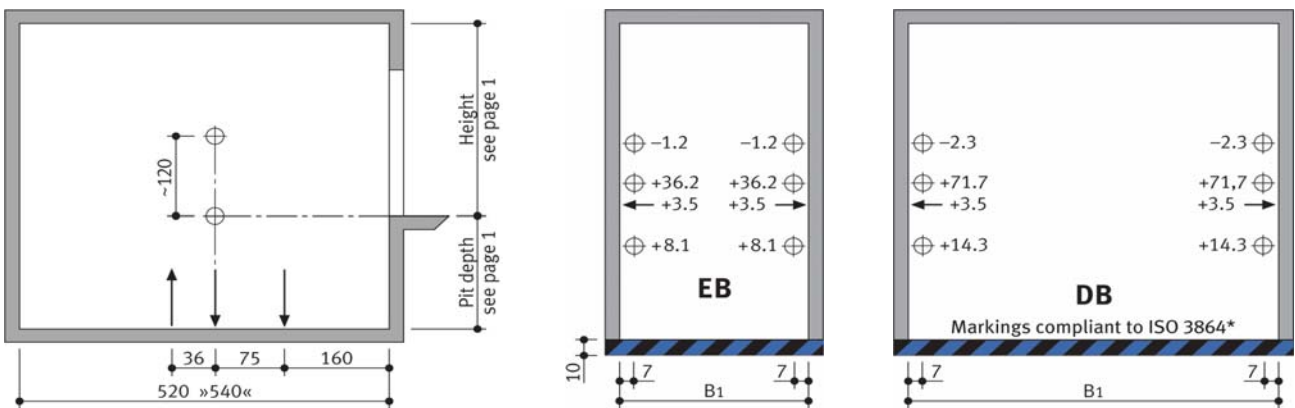

- Units are dowelled to the floor. Drilling depth: approx. 15 cm.  
Floor and walls below the drive-in level are to be made of concrete (quality minimum C20/25)!

\* = Colors used in this illustration are not ISO 3864 compliant

**Installation data**

Free space for longitudinal and vertical ducts (e.g. ventilation)

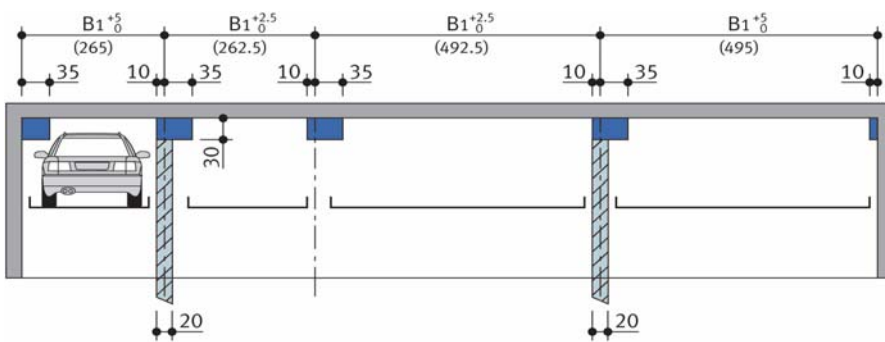

B1, B2, B3 = (see table on page 2)

Free space for vertical pipelines, ventilation branch canals

Free space for horizontal ducting

Approach level

Free space only applicable if vehicle is parked forward = FRONT FIRST and driver's door on the left side.

( ) = Dimensions in brackets illustrate an example for usable platform width 230/460 cm.

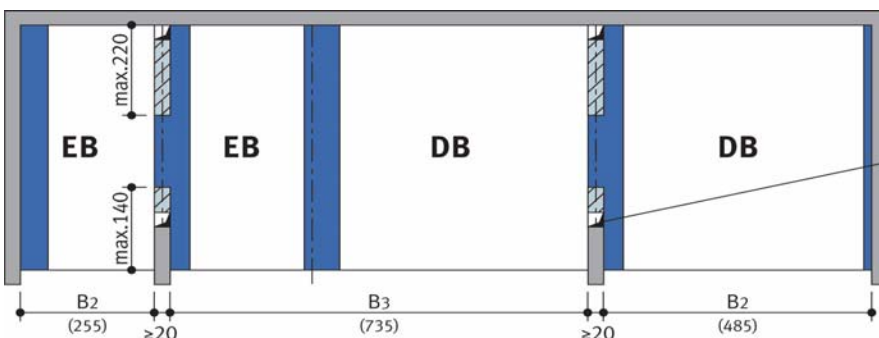

Example for ventilation branch canal and/or vertical pipelines.

## Electrical installation

### Installation diagram

#### Electrical data (to be performed by the customer)

| No. | Quantity   | Description   | Position                       | Frequency    |
|-----|------------|---|--------------------------------|--------------|
| 1   | 1          | Electricity meter   | in the supply line             |              |
| 2   | 1          | Main fuse: 3 x fuse 16 A (slow) or circuit breaker 3 x 16 A (trigger characteristic K, G or C)      | in the supply line             | 1 per unit   |
| 3   | 1          | Supply line 5 x 2.5 mm <sup>2</sup> (3 PH + N + PE) with marked wire and protective conductor       | to main switch                 | 1 per unit   |
| 4   | 1          | Lockable main switch  | defined at the plan evaluation | 1 per unit   |
| 5   | 1          | Supply line 5 x 2.5 mm <sup>2</sup> (3 PH + N + PE) with marked wire and protective conductor       | from main switch to unit       | 1 per unit   |
| 6   | every 10 m | Foundation earth connector  | corner pit floor               |              |
| 7   | 1          | Equipotential bonding in accordance with DIN EN 60204 from foundation earth connector to the system |                                | 1 per system |

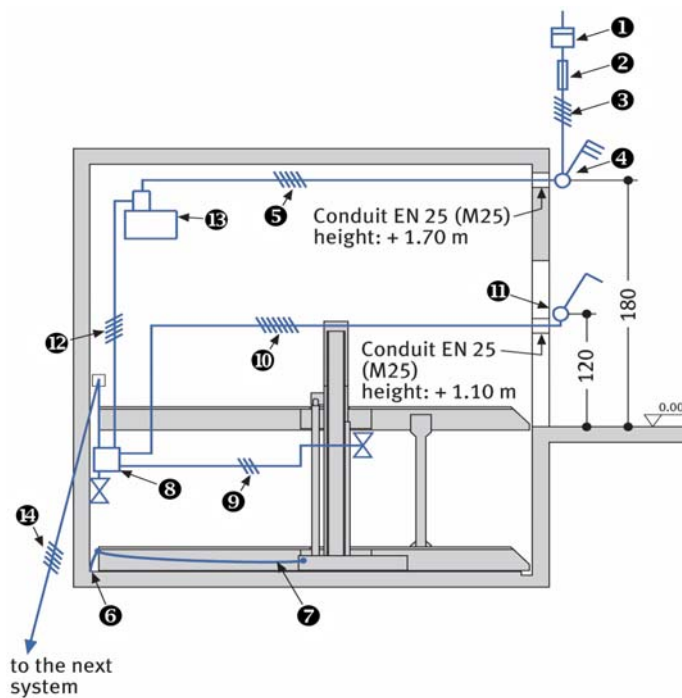

#### Electrical data (included in delivery of **SWISS-PARK** Systems)

| No. | Description  |
|-----|--|
| 8   | Terminal box   |
| 9   | Control line 3 x 0.75 mm <sup>2</sup> (PH + N + PE)                            |
| 10  | Control line 7 x 1.5 mm <sup>2</sup> with marked wire and protective conductor |
| 11  | Operating device   |
| 12  | Control line 5 x 1.5 mm <sup>2</sup> with marked wire and protective conductor |
| 13  | Hydraulic unit 3.0 kW, three-phase current, 400 V / 50 Hz                      |
| 14  | Control line 5 x 1.5 mm <sup>2</sup> with marked wire and protective conductor |

## Technical data

### Range of application

Generally, this parking system is not suited for short-time parkers (temporary parkers). Please do not hesitate to contact your local **SWISS-PARK** agency for further assistance.

### Units

Low-noise power units mounted to rubber-bonded-to metal mountings are installed. Nevertheless we recommend that parking system's garage be built separately from the dwelling.

### Available documents

- wall recess plans
- maintenance offer/contract
- declaration of conformity
- test sheet on airborne and slid-borne sound

### Corrosion protection

See separate sheet regarding corrosion protection.

### Railings

If the permissible drop opening is exceeded, railings are to be mounted on the systems. If there are traffic routes next to or behind the installations, railings compliant to DIN EN 294 must be installed by the customer. Railings must also be in place during construction.

### Environmental conditions

Environmental conditions for the area of **SWISS-PARK** Systems: Temperature range  $-10$  to  $+40^{\circ}$  C. Relative humidity 50 % at a maximum outside temperature of  $+40^{\circ}$  C. If lifting or lowering times are specified, they refer to an environmental temperature of  $+10^{\circ}$  C and with the system set up directly next to the hydraulic unit. At lower temperatures or with longer hydraulic lines, these times increase.

### Sound insulation

According to DIN 4109 (Sound insulation in buildings), para. 4, annotation 4, **SWISS-PARK** Systems are part of the building services (garage systems).

**Normal sound insulation:** DIN 4109, para. 4, Sound insulation against noises from building services.

Table 4 in para. 4.1 contains the permissible sound level values emitted from building services for personal living and working areas. According to line 2 the maximum sound level in personal living and working areas must not exceed 30 dB (A). Noises created by users are not subject to the requirements (see table 4, DIN 4109). The following measures are to be taken to comply with this value:

- Sound protection package according to offer/order
- Minimum sound insulation of building  $R'w = 57$  dB (to be provided by customer)

**Increased sound insulation** (special agreement): DIN 4109, Amendment 4, Information on planning and execution, proposals for increased sound insulation.

**Agreement:** Maximum sound level in personal living and working areas 25 dB (A). Noises created by users are not subject to the requirements (see table 4, DIN 4109).

The following measures are to be taken to comply with this value:

- Sound protection package according to offer/order
- Minimum sound insulation of building  $R'w = 62$  dB (to be provided by customer)

Note: User noises are noises created by individual users in our **SWISS-PARK** Systems. These can be noises from accessing the platforms, slamming of vehicle doors, motor and brake noises.

## To be performed by the customer

### Safety fences

Any constraints that may be necessary according to DIN EN 294 in order to provide protection for the park pits for pathways directly in front, next to or behind the unit. This is also valid during construction. Railings for the system are included in the series and delivered when necessary.

### Numbering of parking spaces

Consecutive numbering of parking spaces.

### Building services

Lighting, ventilation, fire extinguishing and fire alarm systems.

### Drainage

For the front area of the pit we recommend a drainage channel to be connected to a floor drain system or sump (50 x 50 x 20 cm). The drainage channel may be sloped laterally but not the pit floor itself (longitudinal incline is possible). For reasons of environmental protection we recommend to paint the pit floor, and to provide oil and petrol separators in the connections to the public sewage network.

### Marking

According to DIN EN 14 010, a warning that identifies this danger area must be placed in the entrance area that conforms to ISO 3864. This must be done according to EN 92/58/EWG for systems with a pit (platforms within the pit) 10 cm from the edge of the pit.

### Wall cut-through

Any necessary wall cut-through according to page 1.

### Electrical supply to the main switch

Suitable electrical supply to the main switch and the control wire line must be provided by the customer during installation. The functionality can be monitored on site by our fitters together with the electrician. If this cannot be done during installation for some reason for which the customer is responsible, the customer must commission an electrician at their own expense and risk.

### Operating device

Cable conduits and recesses for operating device (for double wing doors: please contact the local agency of **SWISS-PARK**).

#### Operating device exposed

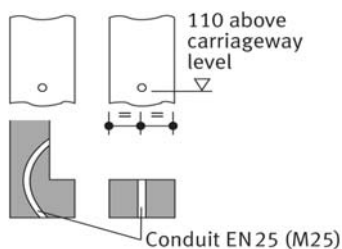

#### Operating device concealed

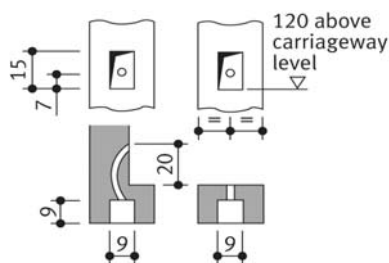

If the following are not included in the quotation, they will also have to be provided / paid for by the customer:

- Costs for final technical approval by an authorized body

## Description Single platform (EB) and Double platform (DB)

### General description

**SWISS-PARK** System providing independent parking spaces for 2 cars (EB), 2 x 2 cars (DB), one on top of the other each.

Dimensions are in accordance with the underlying dimensions of parking pit, height and width.

The parking bays are accessed horizontally (installation deviation  $\pm 1\%$ ).

Vehicles are positioned on each parking space using wheel stops on the right side (adjust according to operating instructions).

Operation via operating device with hold-to-run-device using master keys.

The operating elements are usually mounted either in front of the column or on the outside of the door frame

Operating instructions are attached to each operator's stand.

For garages with doors at the front of the parking system the special dimensional requirements have to be taken into account.

### SWISS-PARK System consisting of

- 2 steel pillars with base elements (mounted on the floor)
- 2 sliding platforms (mounted to the steel pillars with sliding bearings)
- 2 platforms
- 1 mechanic synchronization control system (to ensure synchronous operation of the hydraulic cylinders while lowering and lifting the platform)
- 2 hydraulic cylinders
- 2 rigid supports (connect the platforms)
- 1 automatic hydraulic safety valve (prevents accidental lowering of the platform while accessing the platform)
- Dowels, screws, connecting elements, bolts, etc.
- The platforms and parking spaces are end-to-end accessible for parking.

### Platforms consist of:

- |                          |  |
|--------------------------|--|
| ■ Platform base sections | ■ Central side member [only DB]                                      |
| ■ Adjustable wheel stops | ■ Cross members [DB long and short cross members]                    |
| ■ Canted access plates   | ■ Safety railings – along the upper and lower platform (if required) |
| ■ Side members           | ■ Screws, nuts, washers, distance tubes, etc.                        |

### Hydraulic system consisting of

- Hydraulic cylinder
- Solenoid valve
- Safety valve
- Hydraulic conduits
- Screwed joints
- High-pressure hoses
- Installation material

### Electric system consisting of

- Operating device (Emergency Stop, lock, 1 master key per parking space)
- Terminal box at wall valve

### Hydraulic unit consisting of

- Hydraulic power unit (low-noise, installed onto a console with a rubber-bonded-to-metal mounting)
- Hydraulic oil reservoir
- Oil filling
- Internal geared wheel pump
- Pump holder
- Clutch
- 3-phase-AC-motor (3.0 kW, 230/400 V, 50 Hz)
- Contactor (with thermal overcurrent relay and control fuse)
- Test manometer
- Pressure relief valve
- Hydraulic hoses (which reduce noise transmission onto the hydraulic pipe)

## We reserve the right to change this specification without further notice

The **SWISS-PARK** company reserves the right in the course of technical progress to use newer or other technologies, systems, processes, procedures or standards in the fulfillment of their obligations other than those originally offered provided the customer derives no disadvantage from their so doing.